



RHOPOINT
INSTRUMENTS



HANATEK
INSTRUMENTS

Compact Friction Tester



Operating Instructions

Thank you for purchasing this Rhopoint product.
Please read these instructions carefully before operating this product and retain them for future reference.

English

This instruction manual contains important information about the setup and use of the Rhopoint Hanatek compact friction tester. It is therefore essential that the contents be read before powering up and using the instrument.

If this instrument is passed to other users you must ensure that the instruction manual is supplied with the instrument. If you have any questions or require additional information about this product please contact the Rhopoint Authorised Distributor for your region.

The technology and components used in the device are based on state-of-the art measuring sensors and electronics. As part of Rhopoint Instruments commitment to continually improving the technologies used in their products, they reserve the right to change information included in this document without prior notice.

© Copyright 2020 Rhopoint Instruments Ltd. All Rights Reserved.

Hanatek and Rhopoint are registered trademarks of Rhopoint Instruments Ltd. in the UK and other countries.

Other product and company names mentioned herein may be trademarks of their respective owner.

No portion of the software, documentation or other accompanying materials may be translated, modified, reproduced, copied or otherwise duplicated (with the exception of a backup copy), or distributed to a third party, without prior written authorisation from Rhopoint Instruments Ltd.

Rhopoint Instruments Ltd.
Rhopoint House
Enviro 21 Business Park
Queensway Avenue South
St Leonards on Sea
TN38 9AG UK
Tel: +44 (0)1424 739622

Email: sales@rhopointinstruments.com
Website: www.rhopointinstruments.com
Revision F
May 2020

Contents

Instrument Placement and Handling	3
About the Compact Friction Tester (CFT).....	3
Accessories	3
Functional overview	4
Power	5
Switching on the unit.....	5
Options Menu 1.....	7
Options Menu 2.....	9
Setting Time and Date	10
Adjusting the Home Position	11
Sample Preparation and Loading	13
Adjusting the load cell height.....	15
Making a measurement.....	16
Data transfer	18
Load Cell Protect	19
End Limit Stop.....	19
Calibration Check.....	20

Instrument Placement and Handling

- To ensure safe and reliable operation of this instrument it should be placed on a rigid, flat level surface. Avoid using the instrument in environments where there are vibrations. For best results the instrument should be used in a temperature controlled environment.
- The measurement Load cell of this instrument moves during operation. No obstructions should therefore be placed in its path to prevent or restrict normal operation. Failure to do so could result in measuring cell failure.
- Prevent exposure of the instrument to direct sunlight for prolonged periods and to continuous humidity and condensation.

About the Compact Friction Tester (CFT)

The CFT provides high accuracy friction measurements reported in the unit of coefficient of friction (COF).

The combined graphical display of the friction tester simultaneously shows static and dynamic COF.

The CFT instrument is pre-loaded with the main standards for measuring COF with the option to create a custom test.

Accessories

The instrument is supplied as a standard package complete with all accessories required to power and operate the unit:-

Compact Friction Tester Instrument

24v DC Power Supply

USB Data stick

Micro USB to USB converter

200g Testing Sled

Sample template

Cutting Knife

Functional overview



Figure

<u>Label No.</u>	<u>Function</u>
1	Instrument top plate
2	Display
3	Touch sensitive buttons
4	Automatic lowering system pins
5	Top plate sample clamps
6	Calibration check stand
7	200g Testing Sled
8	Measuring cell and sled link
9	Load cell height adjustment knob
10	USB data connector, Power input and switch

Power

The CFT is powered by a low voltage DC (24v) power supply connected to the instruments power input connector. Located next to the DC power in socket there is a master power switch.



Switching on the unit

With the power supply connected and the master power switch on the instrument is switched on by pressing any of the button indicators on the front screen. There is a 5 second delay after the master switch is turned on before the touch sensitive buttons are active.

Once activated the display will show the last certified date along with the instruments serial number and firmware details. By pressing the touch buttons again the screen will be displayed as shown below.

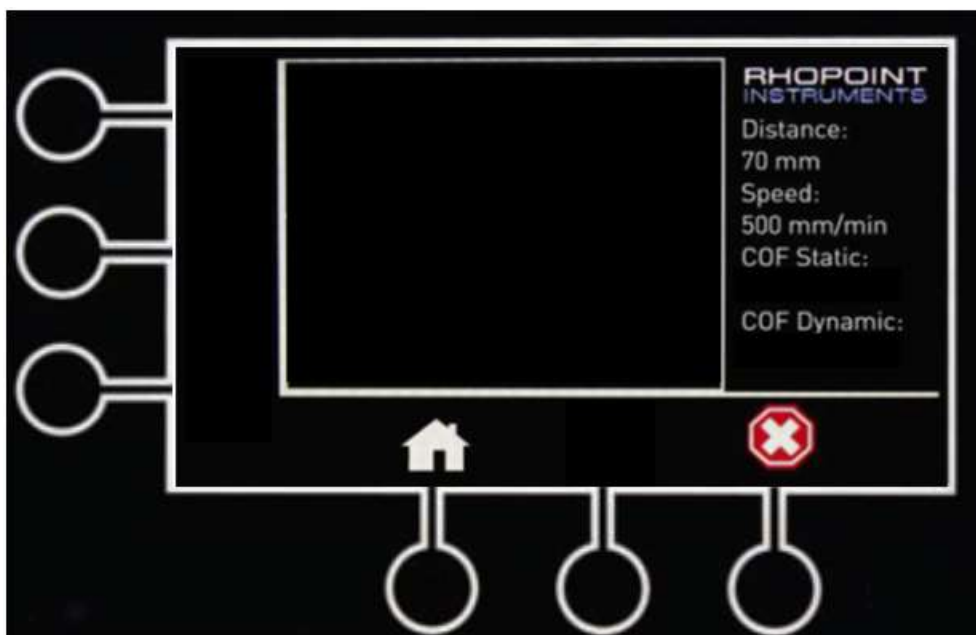

Press the Home Button  to return the load cell arm back to the home position. The Settings and Tare icons will now be displayed.



Always remove the sled and samples from the instrument before returning the load cell to the home position.

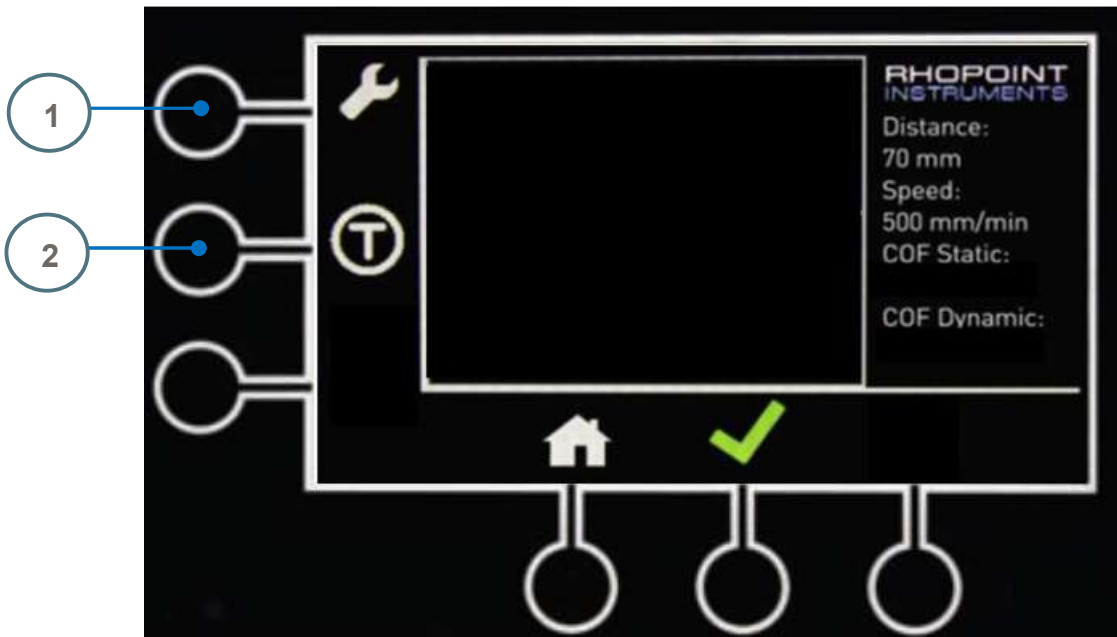

Ensure there is 0 load on the load cell. The sled should be removed from the instrument.

Press and hold the flashing Tare button  for 3 seconds or until a continuous beep is heard indicating the instrument has zeroed.

Options Menu 1

Press the options menu button 

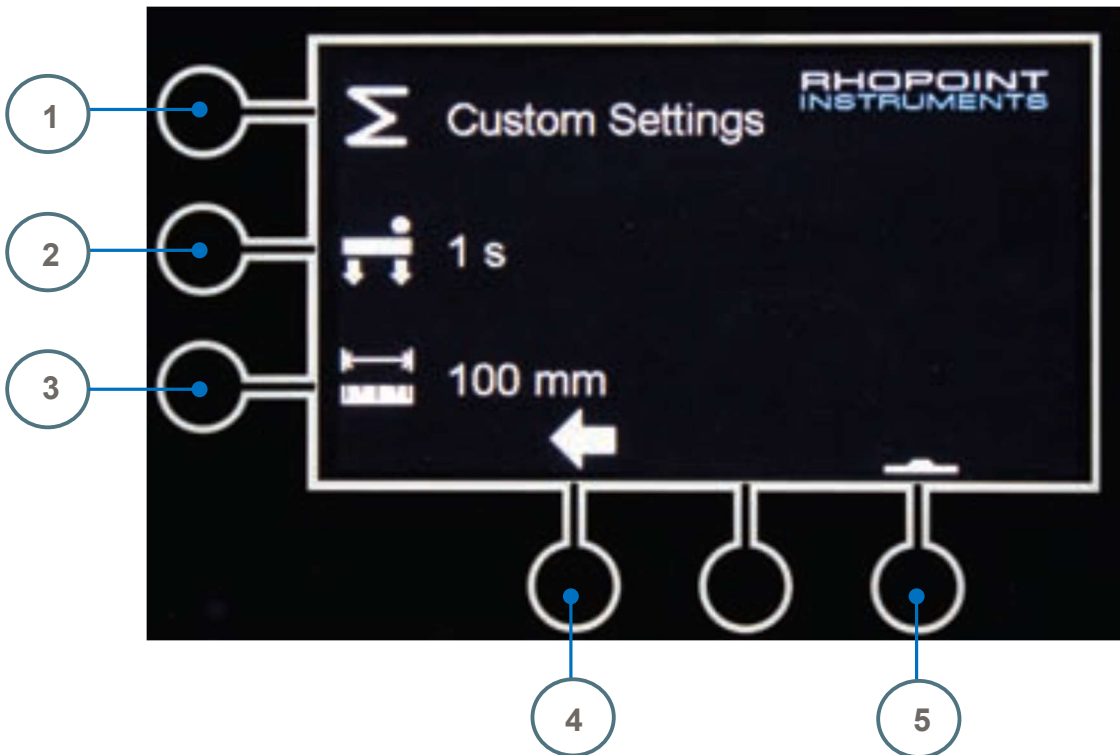

Label No. Function

1	Test Method Options
2	Dwell Time
3	Test Distance
4	Return to Main Screen
5	Options Menu 2

Test Method Options

Pressing this button will enter the test method options menu. The user can select from a pre programmed test method based on several standards or create their own custom method. Pre programmed methods are.

ISO 8295 L	100mm/min
ISO 8295 L	500mm/min
ISO 15359	1200mm/min
ASTM D1894	150mm/min
TAPPI 549	150mm/min

Custom Settings will allow the user to configure test parameters. Press the sled weight icon (A) to cycle between 200, 600 and 800g sled weight.

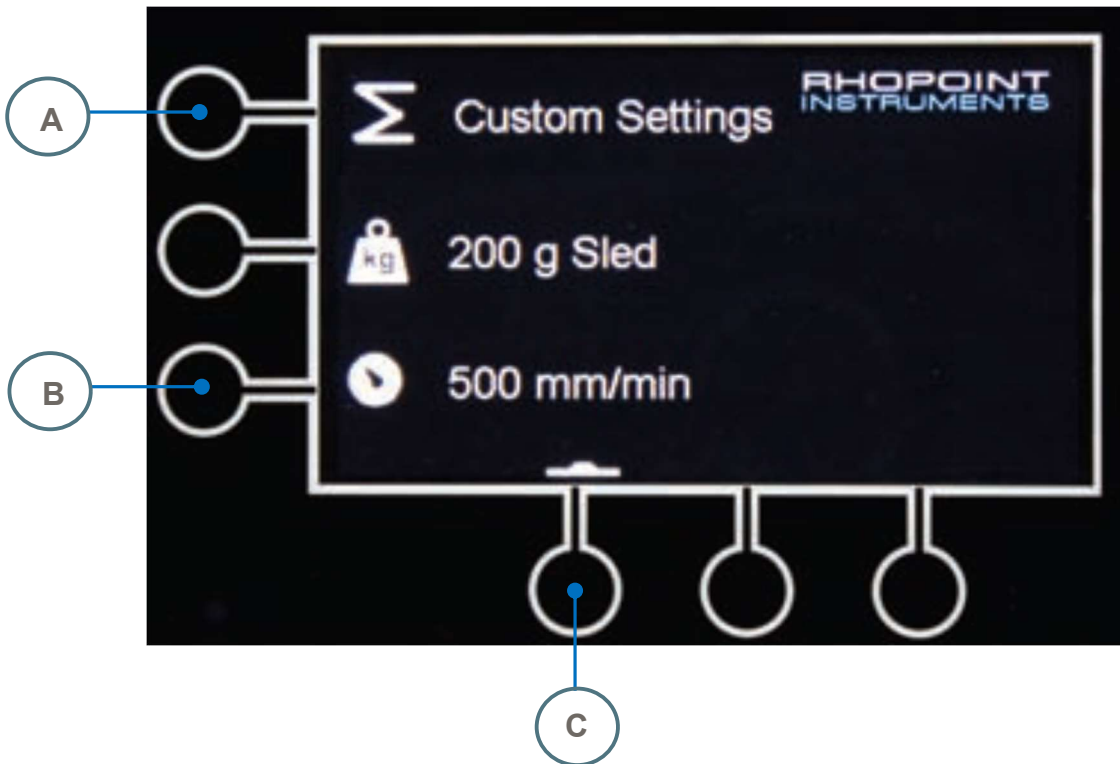

Press the button (C) to return to the main screen.

Press the speed icon (B) will enter a new screen shown below, the speed can be set between 100-1200mm/min in 10mm/min increments. Press the button (C) to return to the previous screen.

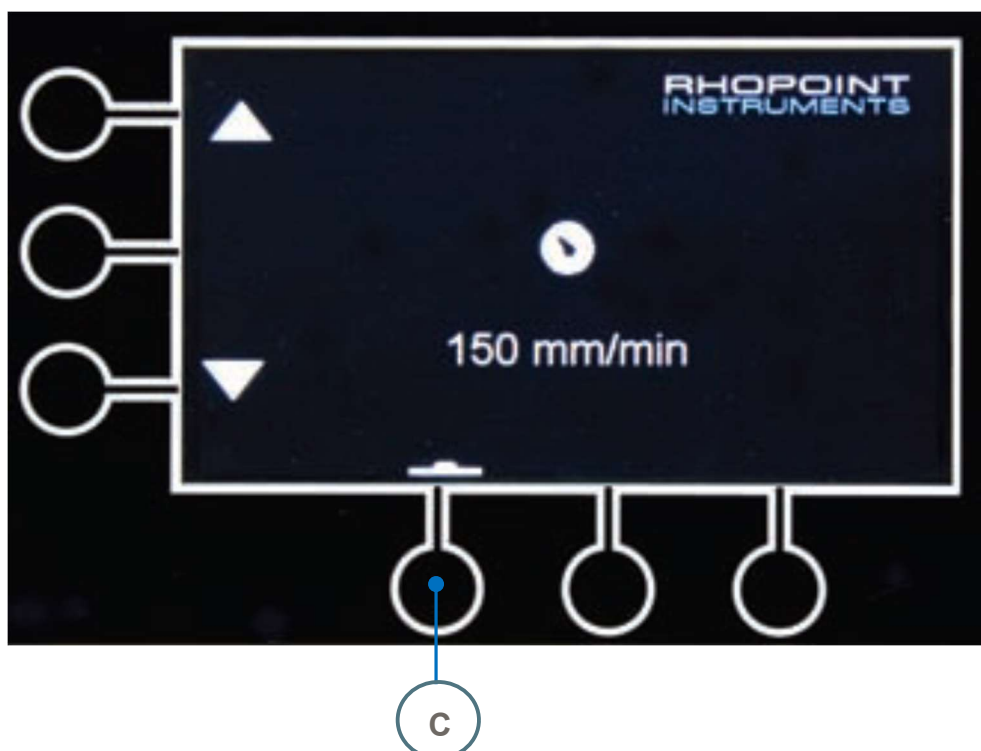

Options Menu 2

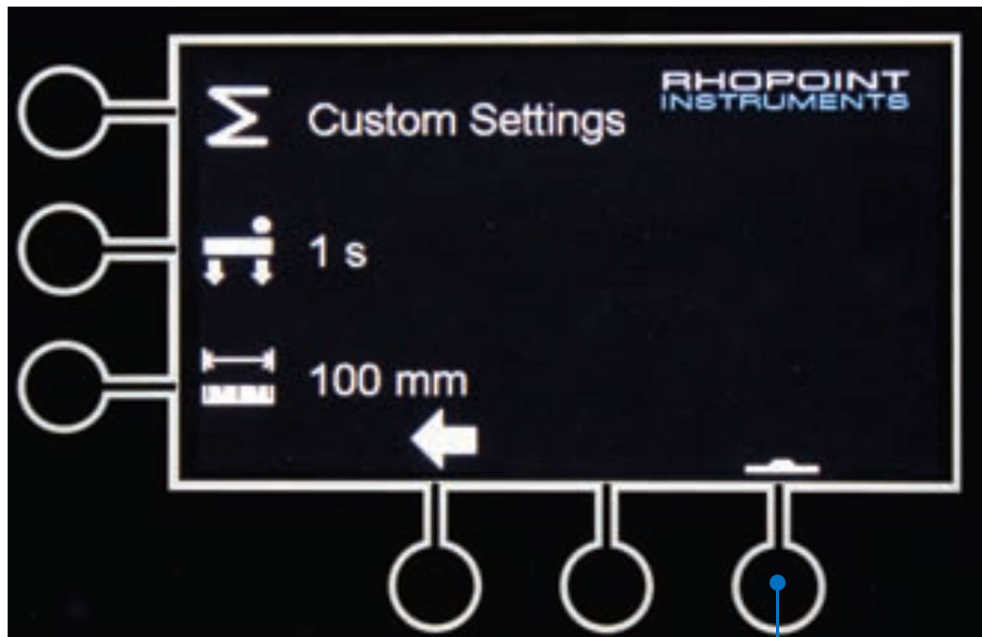

From the options screen 1 press button 5.

5

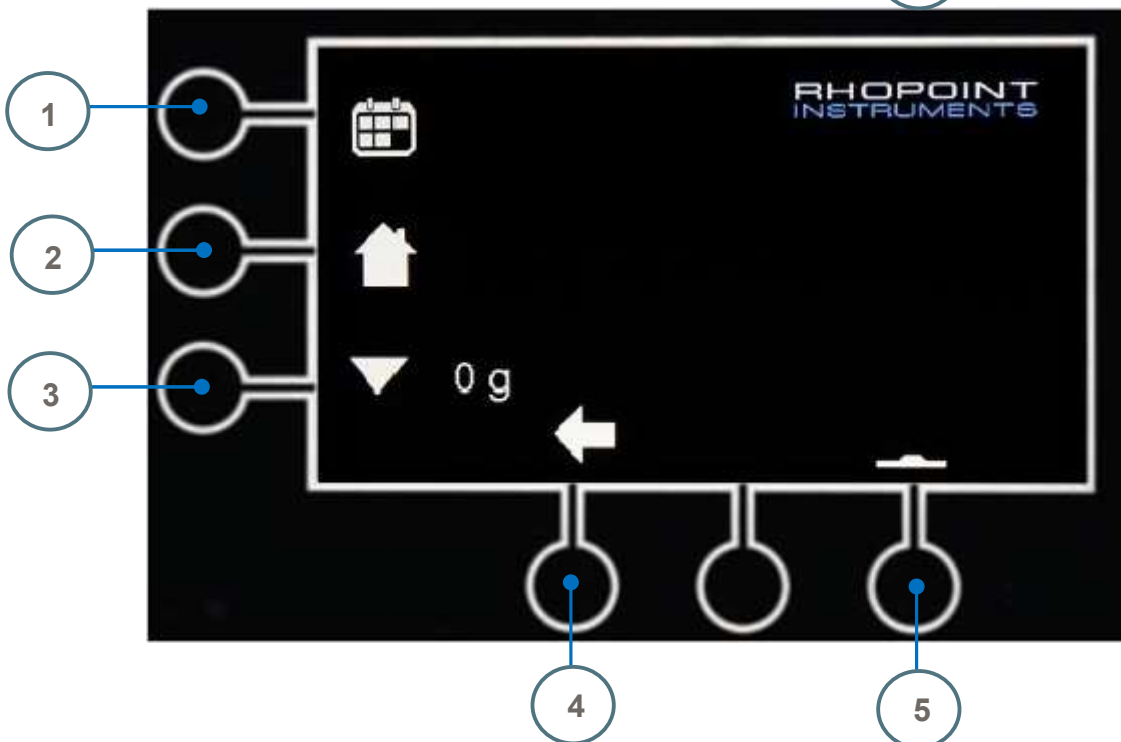

<u>Label No.</u>	<u>Function</u>
1	Time and Date
2	Home Position Adjust
3	Live Load Cell reading
4	Return to Main Screen
5	Options Menu 1

Setting Time and Date

Press button  from options menu 2 to access the time and date screen

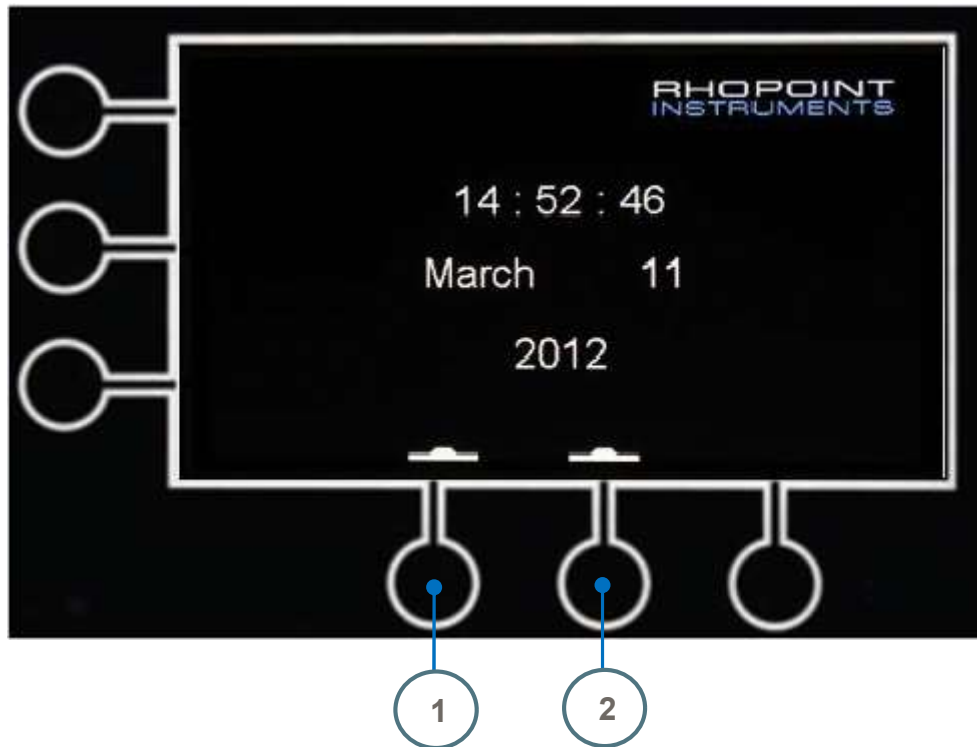

<u>Label No.</u>	<u>Function</u>
1	Return to Main Screen
2	Adjust Time and Date

Press Button 2, the first field to be adjusted will be highlighted in green.

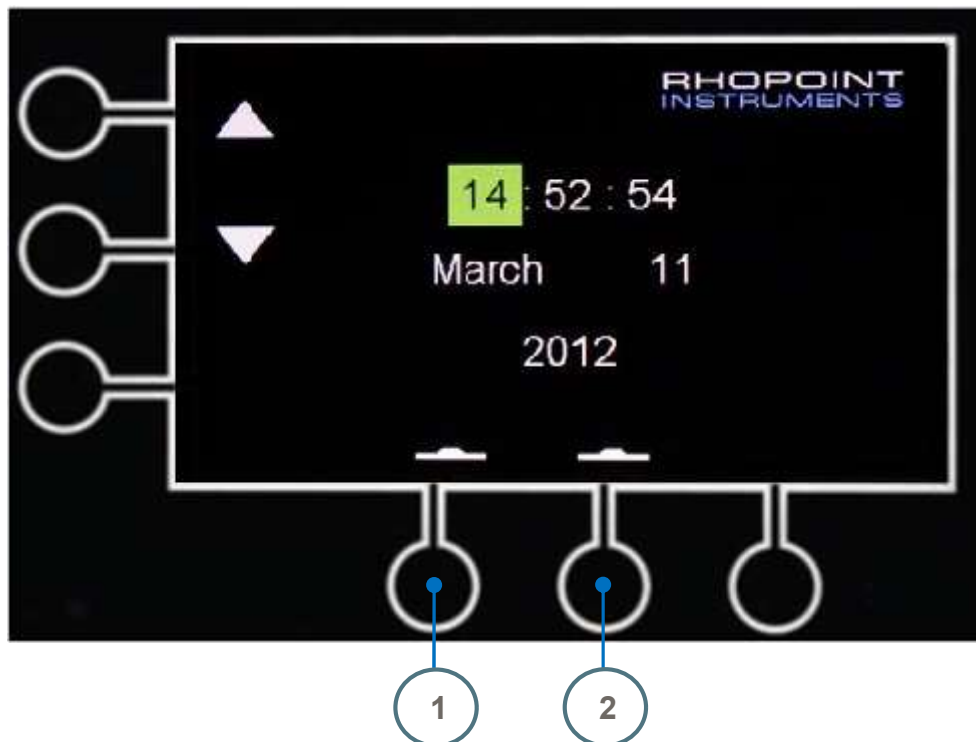

Use the buttons   to adjust the time and date up and down.

Press Button 2 to adjust the next field. Once complete press button 1 to return to the main screen.

Adjusting the Home Position

From the 2nd options menu press the button  to access the home position adjust menu. The image below shows the correct home position. The sled is resting on the lifting pins and the load cell coupling pin is in the centre of the hole on the sled arm.



When in the home position menu press the  button (2) again to move the load cell arm to the current home position setting. The load cell arm will move so ensure there are no obstructions such as the sled.

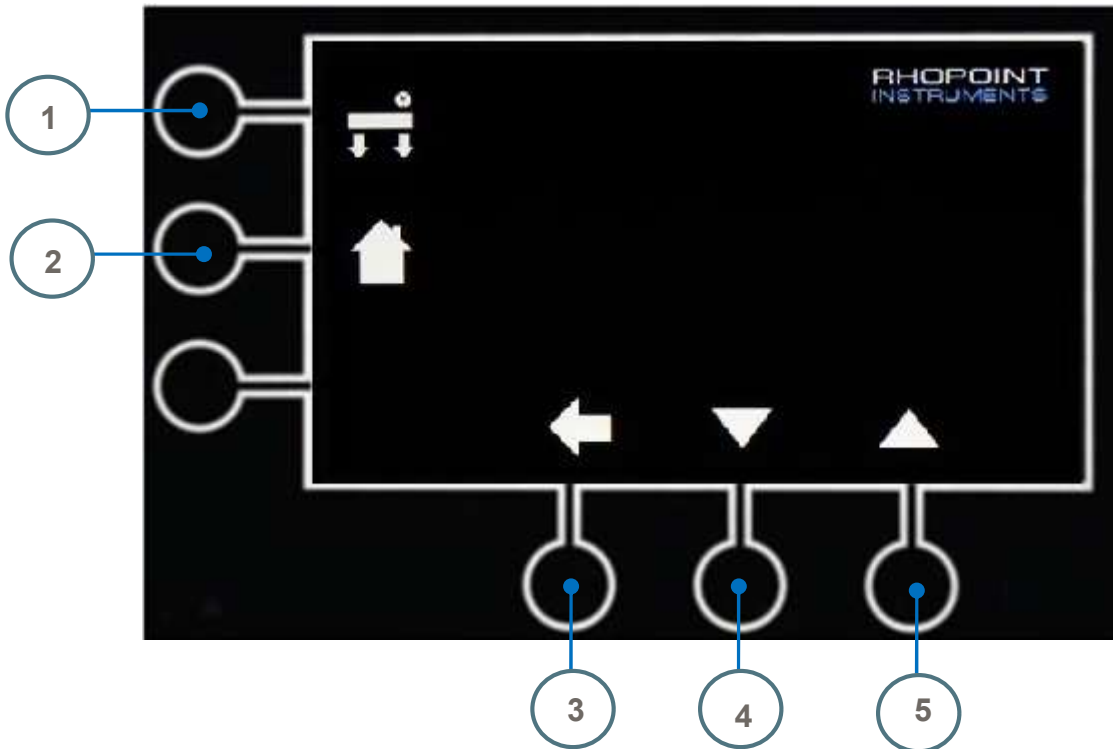

<u>Label No.</u>	<u>Function</u>
1	Lifting pins UP
2	Return to current home setting
3	Return to Main Screen
4	Move load cell arm towards the sled
5	Move load cell arm away from sled

To avoid damage to the measuring cell the position of the load cell arm will not move when the lift pins are in the up position. Pressing the up and down arrows while the lifting pins are up will lower the pins before the movement is made.

Once the correct position has been achieved press the button labeled (3) to return to the main screen.

Sample Preparation and Loading

The CFT is generally used to measure the slip between two surfaces. One sample is placed on the instrument test bed and the other on the sled.

Test Bed Sample

The clamps either end of the instrument test bed will allow a sample of 70mm x 350mm (min) to be secured on the test bed. If the test sample is smaller than this it can be secured at just one end or by using tape. If using tape avoid placing this in the test area practically if measuring thin samples such as plastic film.



The sample size for the sled should be 63.5mm square. When measuring flexible samples the size can be 63.5x148mm and wrapped around the sled. The foam pad on the bottom will ensure a 63.5mm square contact area.

When preparing the samples avoiding contact and manual handling as much as possible as this can change the slip properties of the sample.

Flexible samples

Cut the sample using the template supplied to cut a sample of 63.5x148mm. Place the sled on the sample in the center then wrap the film around the front and back. Use the magnet bars to secure the sample.



* The sled has been calibrated to 200g including the magnet bars. If for any reason the magnet bars cannot be used to secure the sample use tape and then place the magnet bars on top.

Non Flexible Samples

Cut the sample using the template supplied to cut a sample of 63.5x148mm. Rotate the temple through 90deg and then use to trim the length to 63.5 to form a square. Place the sample on the sled using thin double sided tape. Place the magnet bars on the top.



* The sled has been calibrated to 200g including the magnet bars. If for any reason the magnet bars cannot be used to secure the sample use tape and then place the magnet bars on top.

Non Flexible Samples ISO15359 Method

This standard requires the compressible foam pad to be on the test bed instead of the sled. It also requires a mechanism to stop the sled from twisting during the test.

The sled supplied with the CFT is inverted for this test method so the foam pad is facing upwards. The cutout on the sled towing bar helps keep the sled straight during a test.

Use the clamps on the end of the test bed to secure the ISO 15359 test bed foam to the instrument. The sample size for the test bed is the same as the other tests and is placed on the top plate foam. Secure with tape if required.

Cut the sled sample using the template supplied to cut a sample of 63.5x148mm. Trim the length so it covers the full base of the sled, approximately 95mm. Place the sample on the sled and secure with magnet bars either side.

For quicker, easier and safer sample preparation please see the Rhopoint/Hanatek universal sample cutter.



Adjusting the load cell height

The load cell link on the sled and the load cell should be level. If the load cell is too high it will elevate the front of the sled reducing the contact of the sample.

Use the thumb screw on the load cell arm to unlock the mechanism. Manually raise or lower the arm to the correct position and then lock into place by tightening the thumb screw.

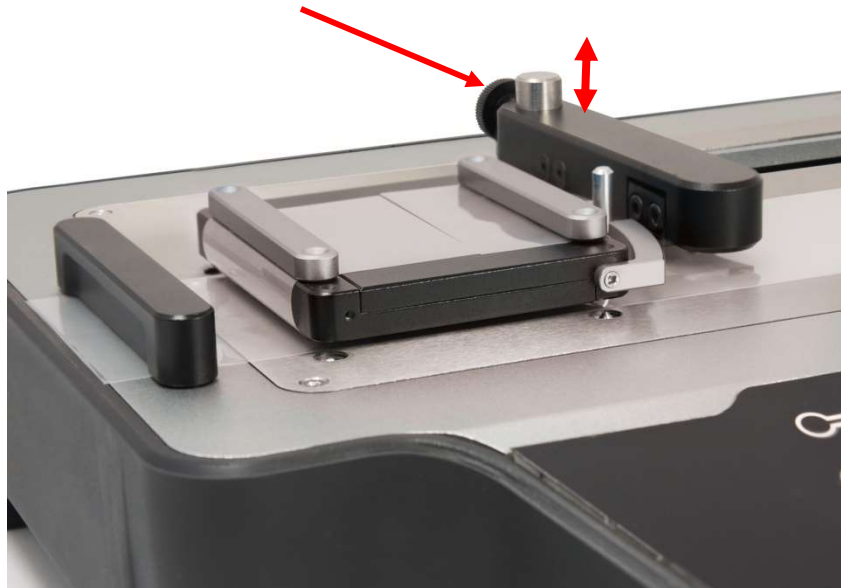

Making a measurement

Once the samples have and fitted to the test bed and sled the test can be run. First check the test parameters on the right of the screen. If anything is incorrect go back to the menu and adjust the test parameters as described earlier in the manual.

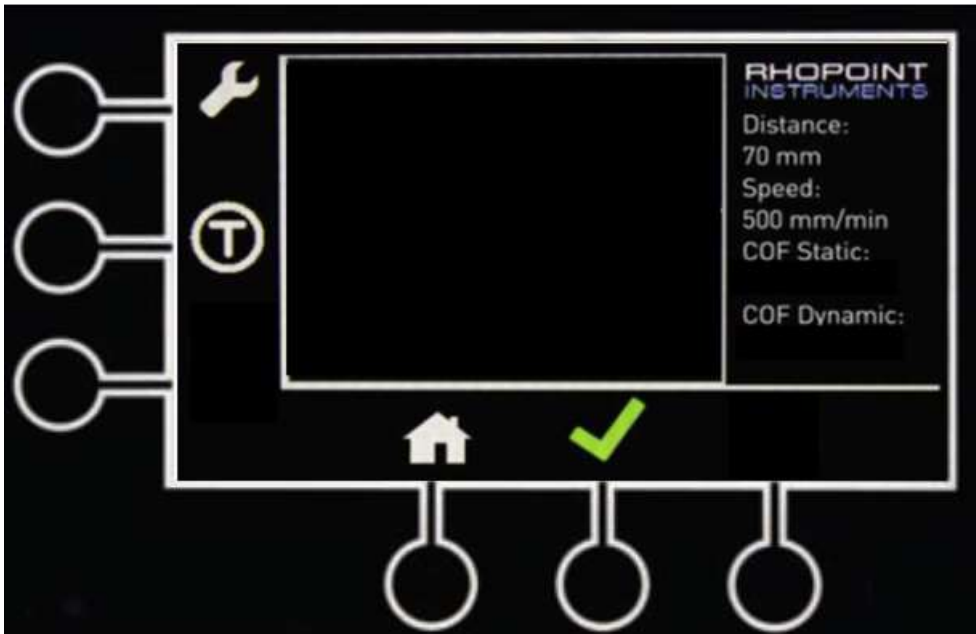

Press the Green tick button  to start the test

During the test run the emergency stop button is shown . Pressing this will abort the test.

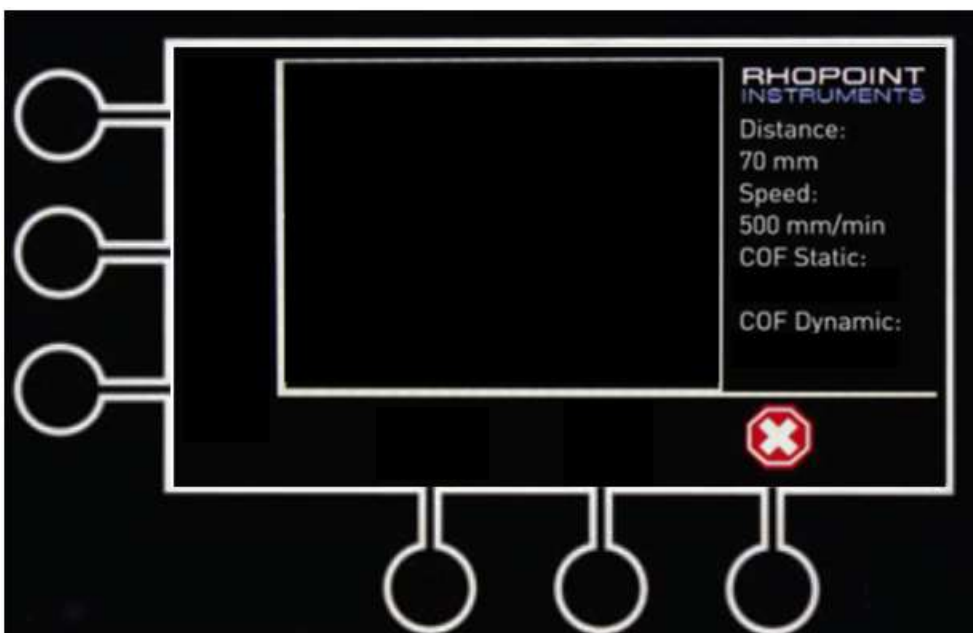

During the test a live reading from the load cell is shown on the graph. When the test has finished the graph will re-scale to maximize the graph display, please note that the scale is fixed after the first reading and is only an indication of test progress. The COF Static and COF Dynamic will be displayed bottom right of the screen.



At this point the data export button is active  press this to export the data to your attached device as described in the next step.

To run a second test, remove the sled and samples from the instrument.
*For accurate COF readings the samples should only be used once.

Press the home button  to return the load cell to the home position.



Always remove the sled and samples from the instrument before returning the load cell to the home position.

Press the Green tick button  to start another test

Data transfer

The CFT instrument has two data transfer options.

Export to USB data stick, (Standard with all instruments)

The data stick included with the instrument allows the transfer of measurement data in .csv format for analysis using Microsoft Excel. By plugging the data stick into the instruments USB interface data is transferred after each measurement by pressing the download key (1) indicated on screen.

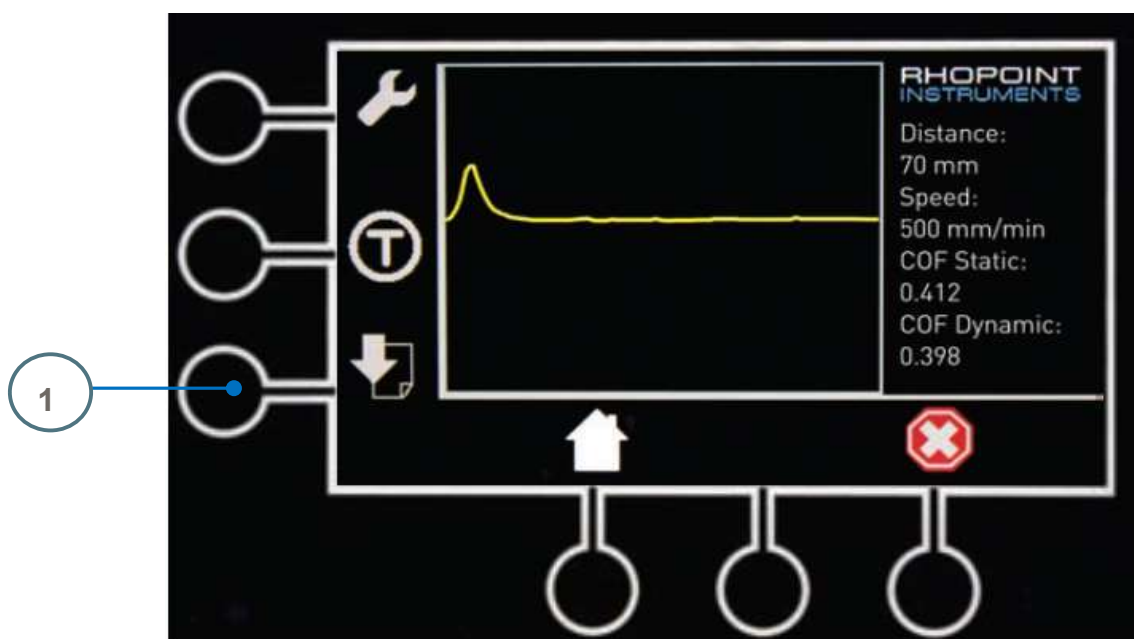

Once the export results button has been pressed the instrument will beep once to indicate a button press and again to indicate the export is complete. The USB stick can then be removed from the instrument and plugged into a PC device.

On the USB stick there will be a file named RESULTS.

The file is a .csv format that can be opened in most commonly used spread sheet programs.

Export to results printer, (optional extra)

Using a custom data cable and pre-programmed label printer the results from the CFT instrument can be sent directly to a label printer.



When testing is complete press the data export button.

The instrument will beep once to indicate a button press and then again to indicate the data has been sent.

Load Cell Protect



The transfer CFT has built in load cell protection.

If during the return of the load cell a negative force is seen the instrument will stop movement.

Move Failure Sensor Stop will be displayed on the screen.

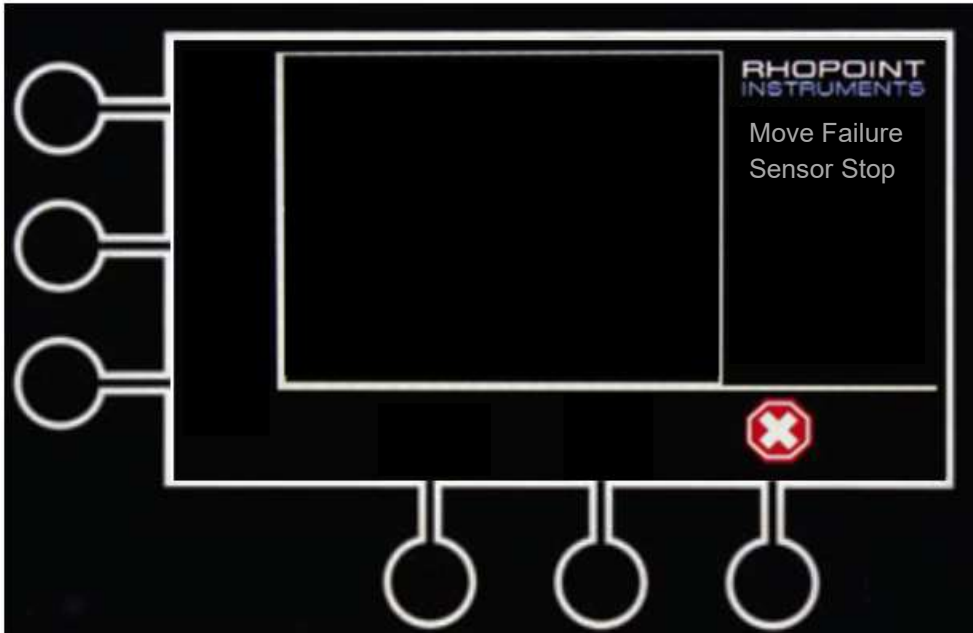

A red cross icon  will flash indicating an emergency stop.



Press the red cross button  and the home button  will become active.
Remove any obstruction from the load cell and press the home button.

End Limit Stop

If the limit of travel is exceeded the message Move Failure Stop will be displayed on the screen. Similar to the above screen image in load cell protect.

Press the red cross button  and the home button  will become active.
Remove any obstruction from the load cell and press the home button.

Calibration Check

Check Zero

From the 2nd options menu press the button 

The instrument will now show a live load cell reading. In normal operation orientation this should be a stable zero reading +/-0.1 drift is acceptable.

If the reading is not zero return to the home screen and press the  button then re-check.

Checking Zero Drift from factory calibration

Power down the instrument and then re-power. Press the home button to activate the options menu.

Navigate to the load cell check in the 2nd options menu as described above.

The reading shown is the reading with no software offset. If this is more the 10g away from 0g the load cell could be damaged and a full calibration check performed.

Checking 200g and full scale range

From the 2nd options menu press the button 

The instrument will now show a live load cell reading. In normal operation orientation this should be a stable zero reading +/-0.1 drift is acceptable.

If the reading is not zero return to the home screen and press the  button then re-check.

Stand the instrument on its end as in the below image.



On the live load cell reading note the value shown. This is the mass of the load cell and sled coupling.

Use calibration weights on the back of the load cell or hang the 200g sled off the load cell coupling to check the force readings of the instrument.

Remember to add the mass of the load cell and coupling to the mass of the sled or calibration weight. For example if the load cell and coupling give a reading of 25g then adding the 200g test sled will give a reading of 225g.



The tolerance is 2% of the reading (approximately 2g)

EU DECLARATION OF CONFORMITY

WE Rhopoint Instruments Ltd, Rhopoint House,
Enviro 21 Park, Queensway Avenue South,
St Leonards on Sea, East Sussex, TN38 9AG

DECLARE UNDER OUR SOLE RESPONSIBILITY THAT THE PRODUCT

Compact Friction Tester (CFT)

**TO WHICH THIS DECLARATION RELATES ARE IN CONFORMITY WITH
THE FOLLOWING STANDARDS**

EN 61326-1:2013
EN 61000-4-3:2006
EN 61000-4-4:2012
EN 61000-4-5:2014
EN 61000-4-6:2014
EN 61000-4-8:2010
EN 61000-4-11:2006
EN 50581:2012

FOLLOWING THE PROVISIONS OF DIRECTIVES

2014/30/EU Electromagnetic Compatibility (EMC Directive)
2011/65/EU Restriction of hazardous substances (RoHS Directive)

Rhopoint Instruments Ltd
10/11/2016



.....
Tony Burrows, Managing Director